

Parts Diagram for Part # 5305SS-P
Overhead Assembly for Morse 82A-SS Series Stainless Steel Mobile-Karrier / Palletizer
Serial Number 0615 to 0117 (MMYY)

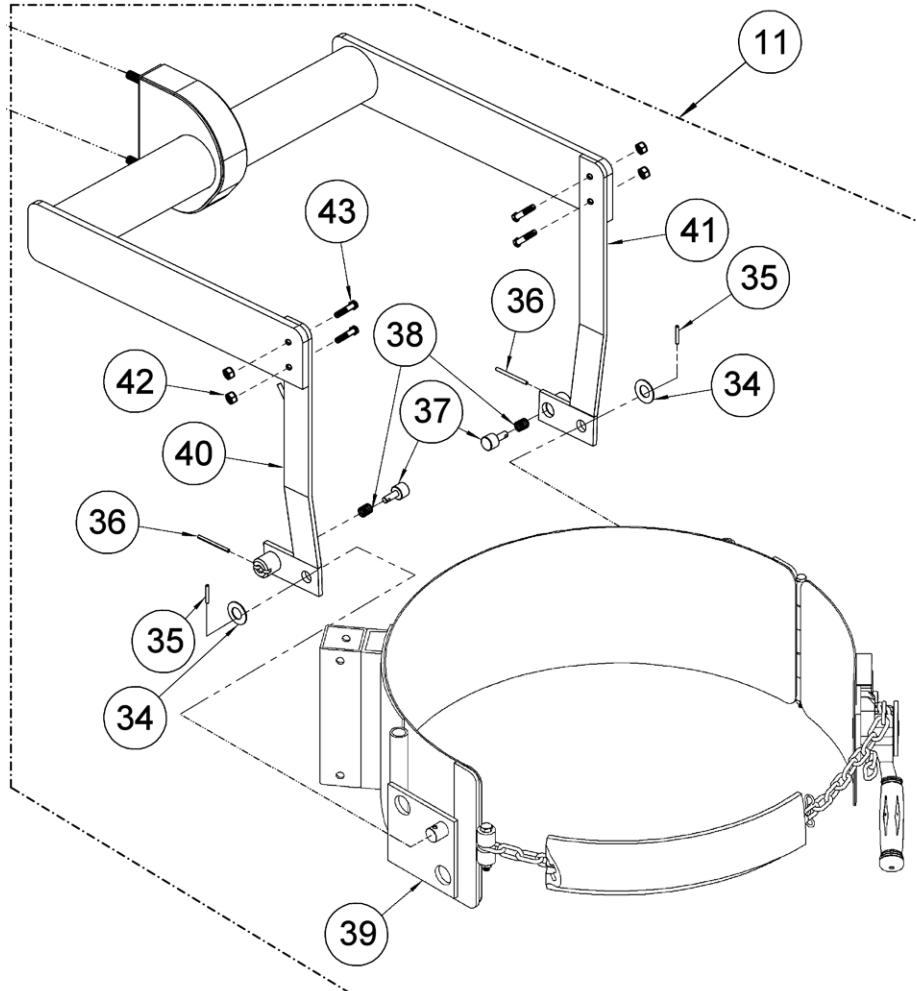

ITEM	QTY.	PART #	DESCRIPTION
11	1	5305SS-P	OVERHEAD ASM, 82A-SS, SS
34	2	62-P	WASHER, 3/4 SPRING
35	2	64SS-P	ROLL PIN, 3/16 X 1-1/4, SS
36	2	61SS-P	ROLL PIN, 3/16 X 2-1/2 SS
37	2	59SS-P	PLUNGER, 80i-SS, 85i-SS
38	2	60SS-P	SPRING, PLUNGER, SS
39	1	101ZSS-P	SADDLE ASM, 80i-SS, 85i-SS
40	1	5316CPTSS-P	LINK ASM, LEFT, 82A-SS, SS
41	1	5317CPTSS-P	LINK ASM, RIGHT, 82A-SS, SS
42	4	810SS-P	NUT, 1/2-13 NYLON LOCK, SS
43	4	805SS-P	BOLT 1/2-13 X 1.25 CARRIAGE SS

* Recommended spare parts.