

MORSPEED 1500™ Forklift Drum Handlers

>> [Click to Watch Video](#) <<

Move more drums with MORSPEED™ 1500

- Lift, move and place rimmed drums right from your forklift
- Mounts on forks in seconds without any tools
- No power connections
- Raise forks to grip drums
- Massive steel jaws grip upper rim of drums
- 1500 Lb. Capacity per drum

All MORSPEED™ Forklift Attachments allow you to grab, lift, move and place drums in minimum time without leaving the driver's seat of your fork truck. Raise and lower the forks to grab and release drums. The massive steel jaws are contoured to securely grasp the drum. They are completely mechanical and automatic.



Model 288-1 is designed to handle one rimmed drum.

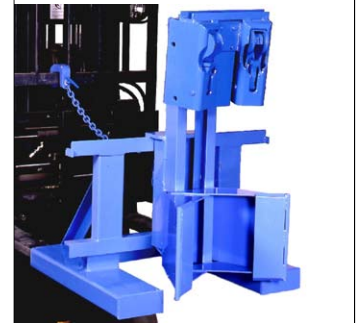

Model 288-1-2H has two heads to handle one rimmed drum.

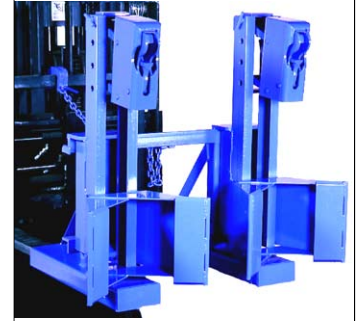

Model 288-2 has two heads to handle one or two rimmed drums at a time.

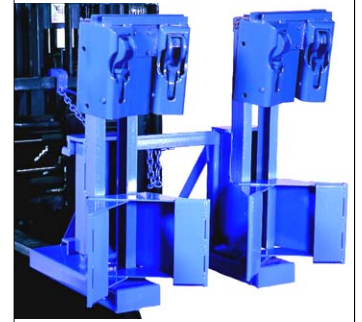

Model 288-2-2H has two heads per drum to handle one rimmed drum.

MORSPEED 1500™ drum handlers work with straight walled drums or even deformed ribs, since they do not depend on the drum ribs or friction. They do not require any modification to your truck. The forklift operator just raises and lowers the forks and drives forward and back as necessary. Handle virtually any rimmed drum in a wide range of sizes and weights:

- Steel drum with closed head or removable top with clamp ring. Plastic drum with non-removable top. Fiber drum with metal clamp ring closure secured.
- Even works with straight walled or damaged drums.
- Requires 24" (61 cm) minimum drum height, but will work with any diameter drum.
- Minimum weight per drum required to actuate jaws:
 - 75 Lb. (34 kg) on a model with one head per drum
 - 350 Lb. (156 kg) with two heads per drum
- Works with or without pallets.
- Contact Morse for advice on suitability of unusual drums or rim shapes.

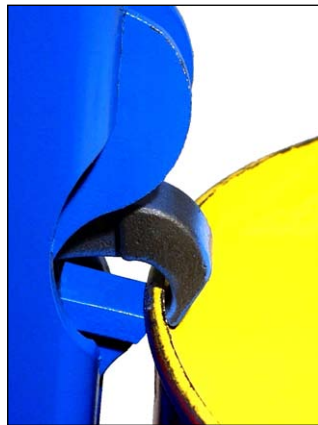

MORSPEED 1500™ has wide jaws contoured to securely grasp virtually any rimmed drum. The encased mechanism provides precise, reliable, automatic drum gripping.



MORSPEED 1500™ models with two heads per drum reduce stress on the rim by distributing the weight between two sets of jaws. This is a feature of models 288-1-2H, 288-2-2H and 287-2H.

Model #	Description
288-1	Fork mount, Handles 1 drum with 1 head
288-1-2H	Fork mount, Handles 1 drum with 2 heads
288-2	Fork mount, Handles 2 drums with 1 head per drum
288-2-2H	Fork mount, Handles 2 drums with 2 heads per drum
287	Carriage mount, handles 1 drum with 1 head
287-2H	Carriage mount, handles 1 drum with 2 heads
2523-P	Belted Backrest Kit
Model #	Description
2839X-P	Crate for export, fully enclosed and heat treated

Model 288-0 Fork Reach Mount is a component of **MORSPEED 1500™** drum handlers, but is NOT a drum handler by itself.

Model 287 Carriage Mount can be mounted directly onto an ITA class 2 carriage without forks for use in tight spaces.

Combine 1 of model 288-0 with 1 of model 287 to make model 288-1 **MORSPEED 1500™** fork mounted drum handler.

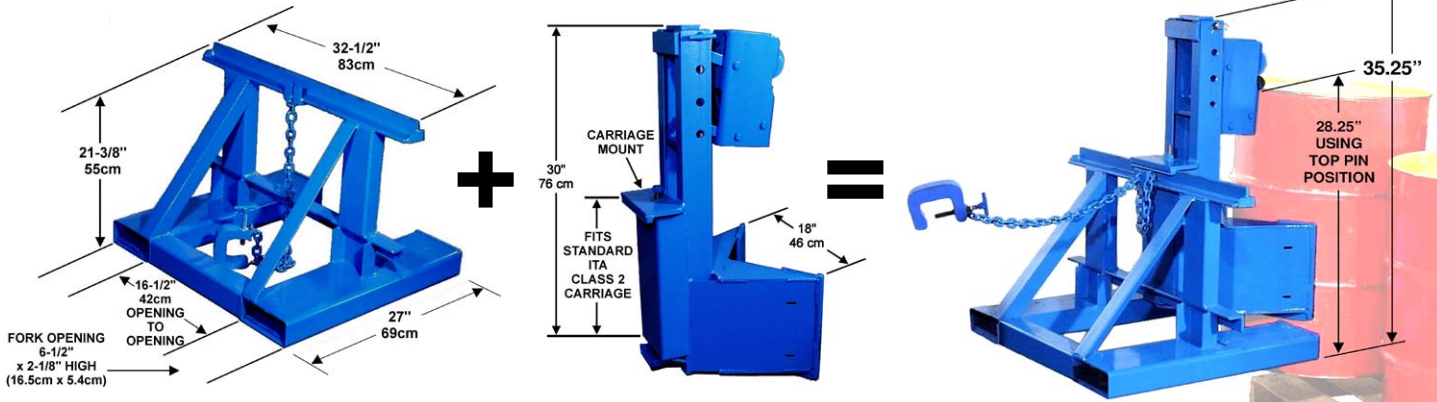

Optional Belted Backrest Kit

IMPORTANT: Order one Belt Kit for EACH drum position on your **MORSPEED 1500™**

- For model 288-1 or 288-1-2H... Order ONE Belt Kit
- For model 288-2 or 288-2-2H... Order TWO Belt Kits

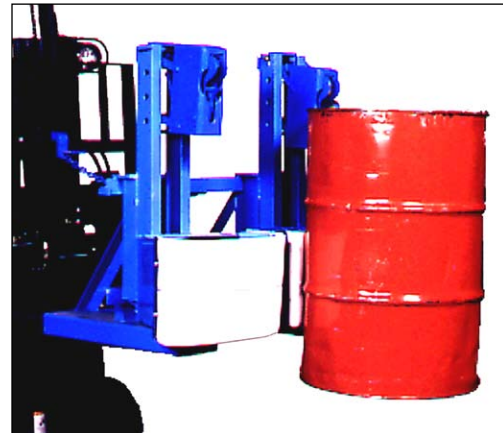
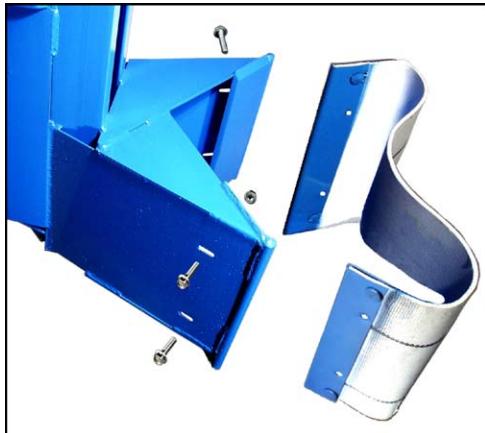

Kit # 2523-P Option puts a shock absorbent surface in front of the steel backrest of the **MORSPEED 1500™** to protect the finish on your drum. It is easy to install using 4 bolts provided. All **MORSPEED 1500™** models use one belt kit per drum.

MORSPEED 1500™ model 288-2 with 2 belt kits installed