

CONTENTS

- **Receiving Procedures**
- **Warranty**
- **Safety Information**
- **Machine Description**
- **Operating Instructions**
- **Maintenance**

Receiving Procedures

Every Morse drum handler is inspected prior to shipping. However, damage may be incurred during transit.

- Check for visible damage. If you choose to accept damaged freight, always sign noting the damage on the **BILL OF LADING**.
- Document the damage and have the truck driver sign. We recommend keeping a digital camera at your receiving dock for this purpose.
- Open packages expeditiously to check the condition of the goods. There is only a 24 hour window to notify the carrier of any concealed damage.
- **IMMEDIATELY REPORT ALL DAMAGE TO THE SHIPPING COMPANY!** Then you may contact Morse for assistance with your freight claim.
- Morse Manufacturing will not be held responsible for any damaged freight that is not signed for as damaged.

Delivery to non-business addresses without a loading dock result in additional freight charges. Residential delivery fees, inside delivery fees, re-delivery charges, and lift gate services will be added by the truck line, and are non-negotiable.

Limited 2 Year Warranty

Morse drum handling equipment is guaranteed against defects in workmanship or materials for **TWO YEARS** when used properly within its rated capacity. Warranty does not cover wear from normal use or damage from accident or abuse. Motors and other purchased parts carry the warranties of their manufacturers.

For warranty claims, contact your Morse Dealer to obtain a return authorization number, and for return freight advice. Return freight must be prepaid.



**Model 620-115
shown**

In all instances, liability is limited to the purchase price paid or to repairing or replacing the product. Customer assumes liability for any modifications, unauthorized repairs or parts substitution.

Safety Information

While Morse Manufacturing Co. drum handling equipment is engineered for safety and efficiency, a high degree of responsibility must be placed upon the machine operator to follow safe practices, based primarily on common sense, upon which true safety depends.

Failure to follow the safety precautions in this manual can result in personal injury or property damage. Observe the same precautions as with similar machinery where carelessness in operating or maintenance is hazardous to personnel. Carefully read the safety precautions below and throughout this manual.

Review the Material Safety Data Sheet(s) for the material(s) in the drum(s) and take all necessary precautions. Safety shoes, work gloves, hard hat and other personal protective devices are recommended.

Prior to initial use, inspect all moving parts and test rotation of drum holder assembly. Inspect saddle assembly for proper operation. Perform necessary load test, inspections, operator training, etc.















DANGER - Indicates a situation which, if not avoided, will result in serious injury or death. This signal word is limited to the most extreme situations.



WARNING - Indicates a situation which, if not avoided, could result in serious injury or death.



CAUTION - Indicates a situation which, if not avoided, can result in damage to the machine.

		<p>CAUTION – Do Not Transport with Drum Raised - ALWAYS LOWER THE DRUM HOLDER TO LOWEST POSITION BEFORE TRANSPORTING. The unit can become unstable when transporting with a raised load.</p>
	<p>WARNING - MORStak Drum Rackers are designed to handle one drum of the types listed in Machine Description. DO NOT attempt to handle any other type of drum or object. DO NOT exceed the weight capacity of 800 Lb. (363 kg).</p>	
	<p>DANGER - Stay Clear of Power Lines. KEEP WELL CLEAR OF POWER LINES. Never approach a power line. Current in a high voltage line may arc some distance from the wire to the steel framed, grounded machine.</p>	
	<p>WARNING - Level Floors Only. For operation only on clean, level floors of suitable bearing capacity. Do not use on sloped surfaces, ramps, irregular or debris strewn floors.</p>	
	<p>WARNING - Rack Drums in Racks with/ Cradles. Use only with suitable, commercially made racks with drum cradles intended by their manufacturer for use with the type, weight and quantity of drums to be used. Racks and drum cradles must be properly designed, installed and maintained.</p>	
	<p>WARNING - Do Not Modify the Unit - Under no circumstances should any modifications be made to the Morse machinery without factory authorization. Any modifications may void the warranty. This machine was designed to perform a specific job and alterations may result in injury to operator or machine.</p>	
	<p>WARNING - No Loose Fitting Clothing - Wear close-fitting clothing and safety equipment appropriate to the job. Loose fitting clothing may become caught on the machinery and cause severe personal injury.</p>	
	<p>CAUTION - Wear Safety Shoes - Wear safety shoes with non-slip soles and hard toe protection.</p>	
	<p>CAUTION - DO NOT allow drum to impact on floor, ground, or dumping station, etc.</p>	
	<p>WARNING - Hydraulic Fluid Under Pressure Can Be Hazardous - Escaping hydraulic fluid under pressure can penetrate the skin, causing serious injury. Avoid the hazard by relieving pressure before disconnecting hydraulic lines. Keep hands and body away from pinholes and nozzles, which eject fluid under high pressure. Use a piece of cardboard to search for leaks. If an accident occurs, see a doctor immediately and inform them of the nature of the accident.</p>	
	<p>WARNING - This product can expose you to chemicals including barium sulfate, cobalt, titanium dioxide, and 2-methylimidazole, which are known to the State of California to cause cancer, and bisphenol-A, which is known to the State of California to cause birth defects or other reproductive harm. For more information go to www.P65Warnings.ca.gov</p>	
	<p>WARNING - This product can expose you to chemicals including lead and arsenic, which are known to the State of California to cause cancer and birth defects or other reproductive harm. For more information go to www.P65Warnings.ca.gov</p>	

Machine Description

The MORStak Drum Racker is designed to handle one 55 gallon (210 liter) steel or plastic drum with suitable top lifting rim ONLY.

Example at right shows 55-gallon (210 liter) plastic drum with suitable top rim.

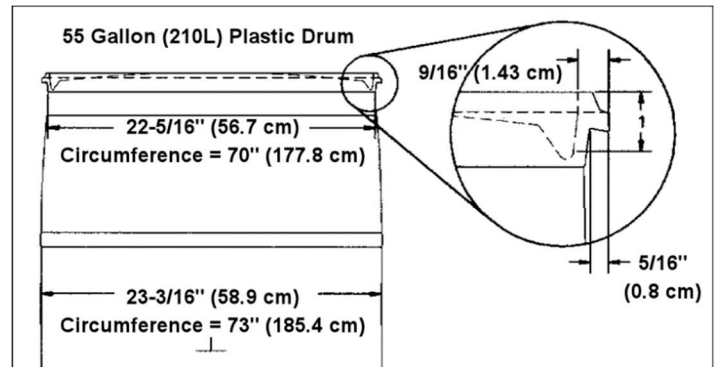

For drums with removable top, the top must be securely fastened.

DO NOT attempt to handle any other type of drum or object.
DO NOT exceed the weight capacity of 800 Lb. (363 kg).

- Two-Stage MORStak (620 series) will pick or place horizontal drum closely spaced on storage rack up to 102" (259 cm) high.
- Single-Stage MORStak (611 series) can rack horizontal drum up to 56" (142 cm) high.
- They both set drum upright on floor.

The front legs require only 5" (12.7 cm) of clearance between the floor and the lowest beam on the rack.



Controls

The Morse drum handler is manually propelled and steered.

Drum lift and tilt controls are powered by 12V DC motor with 4-button pendant.

There are two functions for the operator to control

1. LIFT and LOWER function for vertical positioning of the drum
 - a. Drum LIFT and LOWER Function
 Press the "UP" button to raise drum.
 Press the "DN" button to lower drum.
2. TILT function to control the degree of rotation of the drum
 - a. Drum TILT Function
 Press the "REV" button to tilt drum from vertical to horizontal.
 Press the "FWD" button to tilt drum from horizontal to vertical.



Floor Lock

The floor lock handle is located on the left side of the push handle. Pulling the handle toward the operator until it locks in the down position activates the floor lock. When the floor lock is activated it prevents unwanted free wheeling of the unit. Floor conditions determine the effectiveness of the floor lock. The operator should verify its holding action before depending on it to hold.

Drum Holder (Saddle) Assembly

The drum holder assembly is the component on the MORStak that is intended to grab and hold the drum for moving, tilting, and racking. The drum holder assembly moves vertically along the mast and is designed to mechanically grab the drum by its top rim in the vertical position, and support it with two parallel drum-supporting bars in the horizontal position. A "bridge" between the grip pads at the inside end of the drum holder provides clearance for a typical drum faucet. The operator must see that the drum and faucet are properly oriented to enable the faucet to clear in the space provided by the "bridge" or the faucet may open or be broken and cause a spill.

Important

1. Review the Material Safety Data Sheet(s) for the material(s) in the drum(s) and take all necessary precautions. Safety shoes, work gloves, hard hat and other personal protective devices are recommended.
2. Please read all instructions thoroughly before attempting to operate your new Morse drum handler.
3. The MORStak Drum Racker has a maximum capacity rating of 800 Lb. (363 kg) full drum and 500 Lb. (227 kg) half-full drum and is designed to lift, move and rack a RIMMED 55-gallon (210 liter) steel or plastic drum. DO NOT exceed these ratings. Exceeding these ratings or handling drums other than those mentioned above is unsafe and could result in equipment damage, excessive wear or awkward handling.
4. MORStak Drum Rackers are intended for lifting, moving and racking a drum. Drum may be lifted upright to or from the floor or other suitable surface on dollies, scales, etc.
5. When loading, unloading, operating, or maintaining your Morse drum handler, always use care and good judgment. Maintain secure footing and a firm hold. Keep hands and loose clothing away from all moving parts. Never allow anyone to be below any part of a raised drum handler or drum. Read operating instructions and review the pictures in the sales brochure before operation.
6. Prior to initial use, inspect all moving parts and test rotation of drum holder assembly

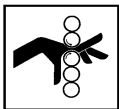

WARNING - Watch Out for Pinch Points.

Stay clear of moving parts. Operator should remain behind the push handle during the lift operation.

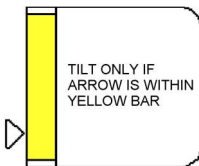

WARNING - Tilt Drum ONLY When Arrow is Within Yellow Bar. The indicator panel shown is located on the safety screen above the push handle. When arrow is within yellow bar, bottom of upright drum will be between 6" (15.2 cm) and 12" (30.5 cm) above floor. The operator should make sure drum holder and drum will not come in contact with floor, rack or other obstruction during tilting of drum, or drum could be dislodged, dropped, or the MORStak could tip over.

Operating Instructions

To Lift an Upright Drum from the Floor and Place Horizontally in a Drum Rack

1. Raise drum holder assembly sufficiently to be tilted to upright without impacting floor.
2. Tilt drum holder assembly down to vertical position.
3. Rotate hand wheel counter-clockwise until grip pads are in full OPEN position.
4. Using the UP (LIFT) and DN (LOWER) functions on control pendant, position drum holder assembly with top rim grip pads several inches (centimeters) above drum.
5. Push MORStak toward drum until the two parallel drum-supporting bars are firmly resting against side of drum.
6. Lower drum holder assembly by pressing DN (LOWER) button on control pendant until the bridge meets the top of the drum. In this position, the top rim grip pads should be 1" to 2" (2.5 to 5 cm) below top drum rim.
7. Rotate grip pad hand wheel clockwise to close grip pads tightly on drum. Ensure that chime catches on two parallel drum-supporting bars are immediately under top rim of drum
8. Raise drum by pressing UP (LIFT) button on control pendant. Grip pads and chime catches will lift drum. Continue to raise only until drum is 6"-12" (15.2 to 30.5 cm) clear of floor, or when arrow indicator is within yellow bar. This height must be sufficient to permit drum to swing clear of floor when tilting to horizontal. Visually inspect drum holder assembly and position of drum to verify proper engagement of grip pads and chime catches.



WARNING - Stay Clear of Raised Drum.
NEVER allow anyone to be below any part of a raised drum handler or drum.
Remain behind the push handle while handling a drum.



WARNING - Do NOT Disengage the Grip Pad when vertical drum is off the ground.
When the drum is in the vertical position, lower the drum to the floor before releasing the grip pad.

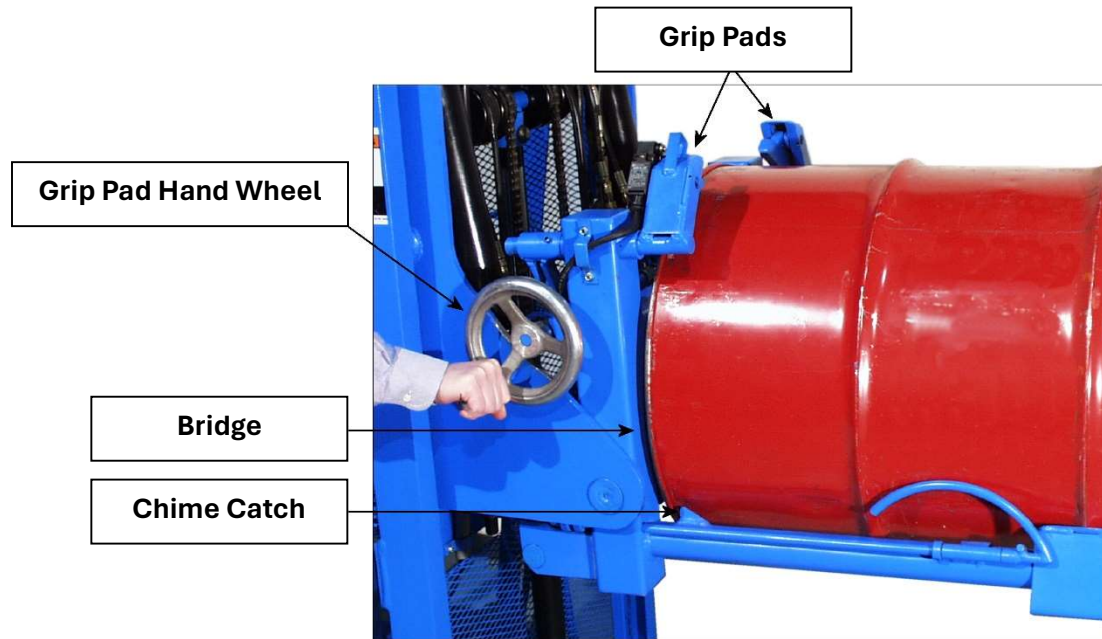

9. After ensuring that the area in front of MORStak Drum Racker is clear, tilt drum to horizontal position. Do not raise drum any farther until you have reached racking area. It can be unsafe to move the MORStak with a raised drum.
10. After drum has been tilted to horizontal position, rotate the grip pad hand wheel counter-clockwise to full open position. This will allow the drum to be cradled by the two parallel drum-supporting bars and allow it to be racked horizontally.

Note: There are interlock switches built into the drum holder which are intended to prevent tilting when drum is not properly positioned. If grip pad or top drum rim is not properly positioned, the tilting function is disabled.
11. Push unit to drum storage area and raise or lower drum to height that is a couple inches (a few centimeters) higher than shelf height. Push unit into storage position and carefully lower drum onto rack. The two parallel drum-supporting bars should be just below the walls of horizontal drum, but still above the rack. This will allow clearance to withdraw the MORStak and leave horizontal drum in stored in rack.

To take a horizontal drum from a rack and place upright on the floor

1. Tilt the drum holder assembly to horizontal position and rotate grip pad hand wheel counterclockwise to full open position.
2. Raise drum holder assembly to approximate elevation of drum to be taken down.
3. Push MORStak up to drum and adjust height of the drum grab, if necessary, to clear drum walls and rack.
4. Roll MORStak forward until the “bridge” meets the head of the drum.
5. Raise the horizontal drum from the rack a few inches and back the MORStak away. Lower the horizontal drum to about 48” from the floor, or until the yellow arrow indicator is within the yellow bar. Rotate the grip pad hand wheel clockwise to close the grip pads tightly on the drum.
6. Carefully tilt the drum down to the vertical position. Lower the upright drum to the floor and when the weight of the drum is entirely on the floor, rotate the grip pad hand wheel counter-clockwise to the full open position. Raise the drum holder assembly about 12”, until the rim grip pads are clearly above the top of the drum. Pull the MORStak back to clear the drum.

Store unit with drum holder assembly in the horizontal position and lowered near the floor.

Maintenance

1. Periodic inspection for the general condition of structural and mechanical components is imperative for safe and efficient operation.
2. Periodically inspect all moving parts, framework, and contact areas for signs of wear, fatigue, or loosening. Tighten, adjust, or replace parts as necessary to prevent failure and maintain proper function.
3. Inspect the hydraulic system for oil drips, hose damage, or other signs of wear. Inspect the level and condition of the hydraulic fluid. (See hydraulic pump specification sheet.) Replace any parts that show signs of wear.
4. Lubricate all moving parts including wheels, casters, and clevis pins.
5. Cleanse machine with compressed air.
6. Cleanse grease fittings and lubricate.
7. Inspect upright assembly for proper adjustment and lubricate rollers.
8. Examine hydraulic sump filter cap; clean or replace if necessary.
9. Measure hydraulic oil level; fill if necessary.
10. Inspect lift and tilt cylinders for leaks.
11. Inspect battery; check water level.
12. Check battery cables and receptacles.
13. Operational check and physical inspection of machine.
14. Check wheel condition.

Parts Information

Worn or damaged parts must be properly replaced with the correct, genuine Morse parts.